



TESA
TECHNOLOGY

INSTRUCTIONS

MODE D'EMPLOI

BEDIENUNGSANLEITUNG

MANUALE D'USO

MODO DE EMPLEO



DIALTRONIC

E

F

D

I

S

**Installing and replacing the battery
(or Power cable)**



Mise en place et remplacement de la
batterie (ou câble Power)

**Einbau und Austausch der Batterie
(oder Power Kabel)**

Installazione e sostituzione della batteria
(o del cavo Power)

**Colocación y sustitución de la batería
(o cable Power)**



No. 0  No. 0 (0,4x2,5mm) 



Battery / batterie / **batterie** / batteria / **batería**: lithium 3V, type CR2032

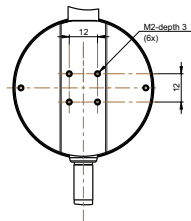
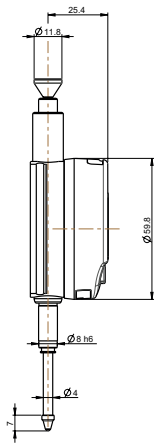

Diagram for rear fixings

Schéma de fixation arrière

Schema für die Befestigung hinten

Schema di fissaggio posteriore

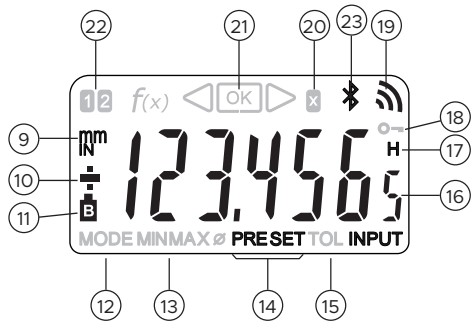
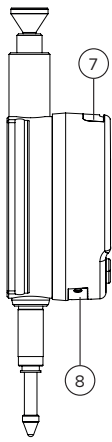
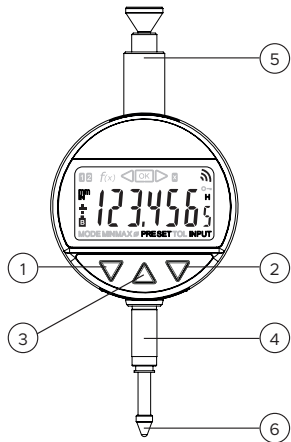

Esquema de fijación posterior



Description

1. MODE button
2. SET button
3. "Favorite" button
4. Clamping \varnothing 8 or 3/8"
5. Lifting cap
6. Measuring insert \varnothing 3/M2.5 or 4-48-UNF
7. Slot for inductive cable
8. Slot for battery or Power Cable
9. Measurement units (mm/INCH)
10. +/- Indicator
11. Low battery
12. Mode menu display
13. MIN/MAX/DELTA mode
14. Preset mode
15. Tolerance mode
16. 6-digit display
17. Hold measured value
18. Button lock
19. Send data
20. Multiplication factor
21. Tolerance indicators
22. Active reference
23. *Bluetooth*[®] active

1 . Operating features of the instrument

-  The instrument has two operating modes: basic functions (direct access) and advanced functions. In addition to the configuration functions, 2 working reference functions can be accessed, in MIN, MAX and DELTA (TIR) mode, plus tolerance display or input of multiplication factor other than 1:1 (see chaps. 3 and 4).
-  The «Favorite» key gives direct access to the function used most often (see chap. 6).
-  Sets a Preset value, reset the MIN/MAX mode, verifies a selection, and controls switching off the instrument.

- Data transmission parameters

4800Bds, 7 bits, even parity, 2 stop bits.

2. Start

Press a button.

For a *Bluetooth*[®] connection (see chap. 6).

3. Basic functions

Each short press on  gives direct access to the basic functions:

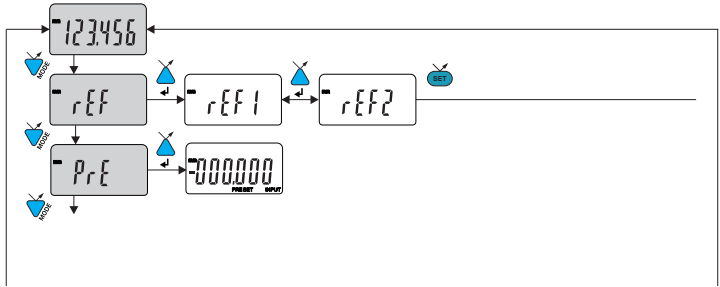

- Choice of reference (REF1 or REF2)

- Inputting a Preset value

-  next digit
-  0...9
-  save PRESET

Note :

- It is possible to assign a different preset value to each of the 2 References. Similarly, different tolerance limits can be assigned to References 1 and 2.

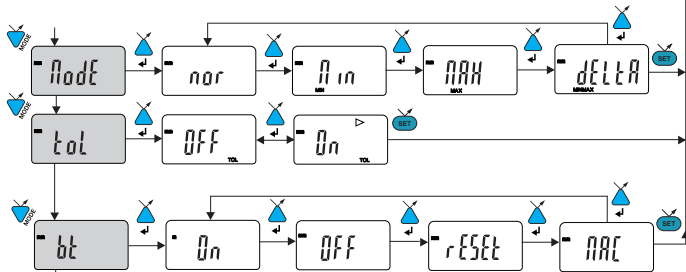

– MIN, MAX measurement DELTA (TIR)

– Tolerance display (inputting tolerance limits, see chap. 5)

– *Bluetooth*[®] (depending on model). Enable / disable, reset *Bluetooth*[®] module or display its MAC address.

4. Advanced functions

Prolonged pressure (>2s) on the required function :



gives access to the advanced functions. Then, each short press on



accesses

E

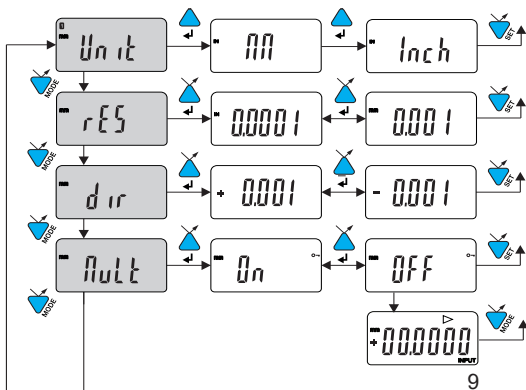

- Unit selection (mm or inch)

- Choice of resolution 0.01 / 0.001 or 0.001 / 0.0001 (depending on version)

- Choice of measurement direction (positive or negative direction)



- Multiplication factor, enable or disable multiplication factor (value can be modified if **On** is confirmed by button)

- Input of multiplication factor, next digit 0....9

save MULT

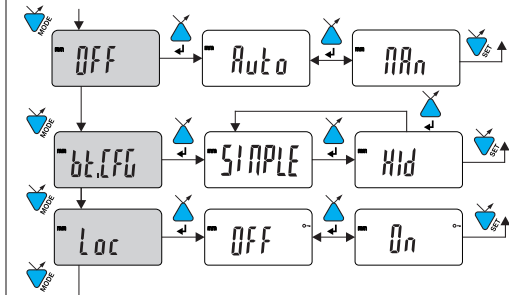
..... continuation



- Automatic switch-off mode
 NAN = disabled. $Auto$ = active (after 10 min. by default).
- *Bluetooth*[®] profile selection (depending on model).
 (see chap. 6 for details)
 The + sign indicates the currently active profile.
- Keypad lock
 Only the favourite key  remains active. (to unlock the keypad, press  for 5 sec).

5. Inputting tolerance limits

To input or modify the tolerance limits, $tol \rightarrow On$ mode should be selected, followed by a short press on  :

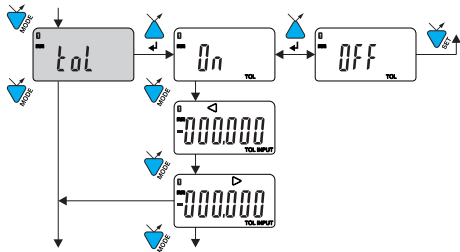

.....Input the lower tolerance limit 

.....Input the upper tolerance limit 



next digit



0...9





save PRESET

Note:



- For measuring internal dimensions, the red and yellow indicators can be switched over by reversing the order in which the tolerance limits are input (lower limit > upper limit).
- It is possible to input different tolerances on REF1 and REF2.

E

- It is also possible to display the tolerance limits when the instrument is operating in MIN, MAX or DELTA (TIR) mode.
- If no tolerance limits have been defined by the user, the instrument will only display the tolerance limit indicators    but will not turn on the indicator lights (red - green - yellow).

6. *Bluetooth*[®] configuration (depending on model)

The connection procedure has been designed to be simple and is signalled by the following three states:

- Symbol  off..... disconnected mode
- Symbol  blinking..... advertising mode
- Symbol 

The following options can be selected to control the *Bluetooth*[®] module.

- On* Enable *Bluetooth*[®] module (start advertising mode).
- OFF* Disable *Bluetooth*[®] module (terminate active connection).
- rESET* Clear pairing information.
- NAE*

Two Bluetooth® profiles are available.

SIMPLE Profile without pairing (default).

Hid Virtual keyboard mode (compatible with recent equipment without driver installation).

Note:

- *Bluetooth*® pairing information is cleared when the profile is changed.

Connection :

- 1° Activate *Bluetooth*® compatible software and hardware (Master : PC, Display Unit).
- 2° Start the instrument. By default the *Bluetooth*® module is active and the instrument is available for connection (advertising mode).
- 3° If no connection is established during the advertisement period reactivate the *Bluetooth*® module using the *bt / On* menu.
- 4° Instrument is ready to communicate (connected mode.)

Only with paired profile :

Pairing with master is automatically done at first connection.

To connect the instrument to a new master (new pairing), pairing information on the instrument must be cleared using the *bt / rESt* menu.



6.1 *Bluetooth*[®] specifications

Frequency Band	2.4GHz (2.402 - 2.480GHz)
Modulation	GFSK (Gaussian Frequency Shift Keying)
Max Output Power	Class 3: 1mW (0dBm)
Range	Open space: up to 15m Industrial environment: 1-5m
Battery life	Continuous : up to 2 months - Always connected with 4 values /sec. Saver : up to 5 months - The instrument sends value only when the position has changed. Blind/Push : up to 7 months - Value is sent from the instrument (button) or requested from the computer.

7. Favorite key

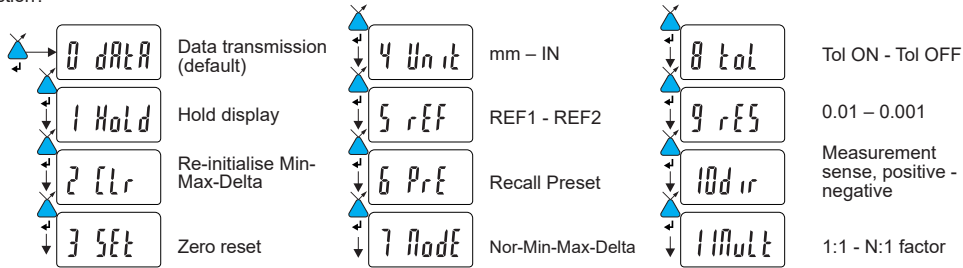
The «Favorite» key gives direct access to a predefined function, and can be configured according to the needs of the user. In order to assign a function to the «Favorite» key, give a prolonged press on , and then select the required function:



Validation of selection: By a prolonged press on  or a short press on  or 

Note: a function can also be assigned via RS232 using the command <FCT + Function No.>
example: Change of Unit = <FCT4>

8. Switching off

The dial gauge goes automatically into stand-by if not used for 20 minutes, unless Auto OFF mode has been turned off (see Chap. 4, advanced functions).

Stand-by mode can be forced by a prolonged press (> 2 sec) on

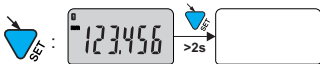

In stand-by mode, the value of the origin is retained by the sensor, and the instrument automatically restarts with any movement of the measurement probe, RS command or press a button.

The instrument can be switched off completely for a long period of non-use, but this will necessitate a zero reset on restart (the origin will be lost):



9. Re-initializing the instrument

The initial instrument settings can be restored at any time by a prolonged press (>4 sec) simultaneously on



Nevertheless the instrument retains its configuration settings (units and resolution), as well as the last active reference.

10. Connecting the instrument

The instrument can be connected to a peripheral via a inductive, Power (Power-USB). See page 2 for connecting the Power cable.

Measured values can be transmitted and the instrument driven using predefined commands (see chap. 11 for a list of the main retro-commands).

Note:

In Tolerance mode, the tolerance limit lights remain lit only for a few seconds while the measurement stabilises. On the other hand, they will remain lit continuously if the instrument is connected to, and powered by, the Power RS (USB) cable.

11. List of the main commands

Selection and configuration

CHA+ / CHA-	Change measurement direction
FCT0 ...9...A...F	Assign «favourite» function
MM / IN	Change measurement unit
KEY0 / KEY1	Lock / unlock keypad
MUL [+/-]xxx.xxxx	Modify multiplication factor
PRE [+/-]xxx.xxx	Modify preset value
REF1 / REF2	Change active reference
STO1 / STO0	Activate / de-activate HOLD
TOL1 / TOL0	Activate / de-activate tolerances
ECO1 / ECO 0	Activate / de-activate economic mode
LCAL dd.mm.yy	Modify last calibration date
NCAL dd.mm.yy	Modify next calibration date
NUM x...x (up to 20chars)	Modify the instrument number
TOL +/-xxx.xxx +/-yyy.yyy	Inputting tolerance limits
MIN /MAX /DEL /NOR	Selecting MIN, MAX, Delta, Normal mode
CLE	Re-initialisation of MIN, MAX or Delta
UNI1 / UNIO	Activate / de-activate change of units
OUT1 /OUT0	Activate / de-activate contin. data transmission

PRE ON / PRE OFF	Activate / de-activate Preset function
PRE	Recall Preset
SET	Zero reset
RES1 / RES2 / RES3	Change of resolution

SBY xx xx number of minutes before stand-by

BT0/BT1	Activate / de-activate <i>Bluetooth</i> ® module
BTRST	Clear pairing information

Interrogation

CHA?	Measurement direction?
FCT?	«favourite» function active?
UNI?	Measurement unit active?
KEY?	Keypad locked?
MUL?	Multiplication factor?
PRE?	Preset value?
REF?	Reference active?
STO?	Status of HOLD function?
TOL?	Current tolerance limit values?
ECO?	Current economic mode
LCAL?	Date of last calibration?
NCAL?	Date of next calibration?
NUM?	Instrument number?
?	Current value (mode Tol, value followed by <=>)
MOD?	Active mode (MIN, MAX, Delta or Normal)?
SET?	Main instrument parameters?
ID?	Instrument identification code?

Maintenance functions

BAT?	Battery status (BAT1 = OK, BAT0 = low battery)
OFF	Switch-off (wake up using a button or RS)
RST	Re-initialisation of the instrument
SBY	Put instrument in stand-by
VER?	Version No. and date of firmware

MAC? *Bluetooth*® MAC address ?

12. Specifications

0,001 mm resolution (IP rating)	01930315 (IP54)	01930317 (IP54)
Measurement range:	12,5 mm	25 mm
Max error (0,01mm resolution):	10 μm	10 μm
Max error (0,001mm resolution):	3 μm	4 μm
Repeatability:	2 μm	
Weight:	119 g	123 g
Measurement force (standard):	0,65-0,90 N	0,65- 1,15 N
Max. speed of travel:	1,7 m/s	
No. of measurements/ sec:	measurement: 10 mes/s	MIN/MAX mode: 20 mes/s
Measurement unit:	metric/english (Inch)	
Maximum Preset (0,01 mm resolution):	$\pm 9999,99$ mm / ± 399.9995 in	
Maximum Preset (0,001 mm resolution):	$\pm 999,999$ mm / ± 39.99995 in	
Measurement system:	Inductive system	
Power:	1 x 3 V lithium battery, type CR2032, 220mAh	
Average consumption:	75 μA	
Average battery life:	8'000 hours	
Data output:	<i>RS232 compatible / Bluetooth® 5 (see chapter 6)</i>	
Working temperature (storage):	+5 to +40°C (-10 to +60°C)	
Electromagnetic compatibility:	as per EN 61326-1	
IP rating (in accordance with IEC60529):	IP 54	
Fixing and space envelope:	\varnothing 8h6 (3/8"), interchangeable M2,5 (4-48-UNF) probe (as per DIN 878)	

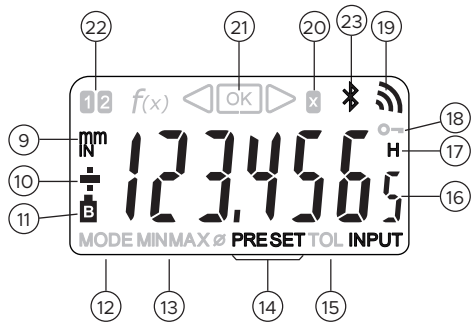
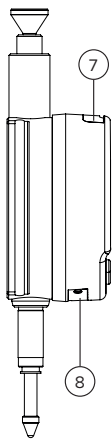
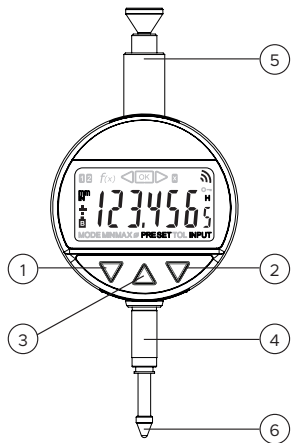

F



Description

1. Bouton MODE
2. Bouton SET
3. Bouton "Favoris"
4. Canon de fixation Ø 8 ou 3/8"
5. Bonnette de relevage
6. Touche à bille Ø 3/M2.5 ou 4-48-UNF
7. Logement pour câble inductif
8. Logement batterie ou câble Power
9. Unité de mesure (mm/INCH)
10. Indicateur +/-
11. Batterie faible
12. Indication du menu MODE
13. Mode MIN/MAX/DELTA
14. Mode Preset
15. Mode tolérance actif
16. Affichage 6 digits
17. Gel de la valeur de mesure
18. Verrouillage des boutons
19. Envoi de données
20. Facteur de multiplication
21. Indicateur des tolérances
22. Indicateur de la référence active
23. Connexion *Bluetooth*[®]

1. Les fonctionnalités de l'instrument

-  L'instrument possède 2 modes de travail : fonctions de base (avec accès direct) et fonctions avancées. En plus des fonctions de configuration, vous pouvez accéder à 2 références de travail, au mode MIN, MAX et DELTA (TIR), à l'affichage des tolérances, ou à l'introduction d'un facteur de multiplication (voir chap. 3 et 4).
-  Le bouton « favori » permet d'attribuer un accès direct à la fonction principalement utilisée (voir chap. 6).
-  Le bouton « SET » permet d'attribuer une valeur de Preset, de réinitialiser le mode MIN/MAX, de valider une sélection, et de gérer l'extinction de l'instrument.

- Paramètres de transmission de données

4800Bds, 7 bits, parité paire, 2 stop bits.

2. Démarrer

Presser un bouton.

Pour une connexion *Bluetooth*[®] (voir chap. 6).

3. Fonctions de base

Chaque pression courte sur  permet un accès direct aux fonctions de base :

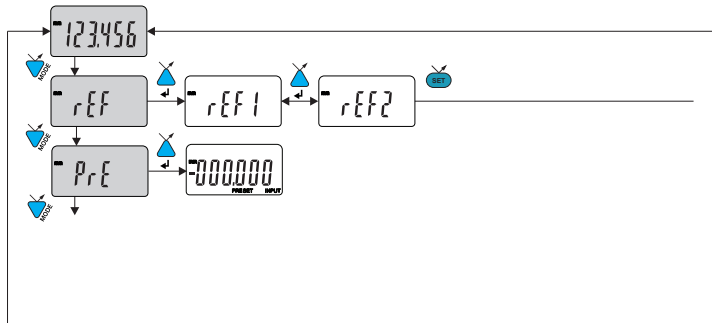

– Choix de la référence
(REF1 ou REF2)

– Introduction d'une valeur de Preset

-  prochain digit  0...9
-  sauve le PRESET

F

Remarque :

- Il est possible d'attribuer une valeur de preset différente à chacune des 2 Références. De même, on peut attribuer des limites de tolérances différentes sur les références 1 et 2.

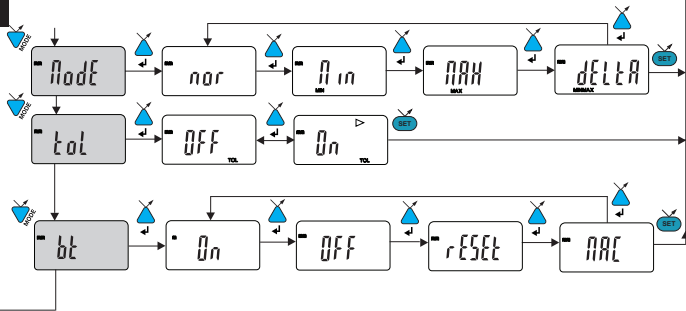

..... suite

F



- Mesure du MIN, MAX et DELTA (TIR)
- Affichage des tolérances (introduction des limites de, tolérance, voir chap. 5)
- Bluetooth® (selon version). Activation / désactivation, réinitialisation du module Bluetooth® ou affichage de l'adresse MAC.

4. Fonctions avancées

Une pression longue (>2s) sur  permet d'accéder aux fonctions avancées. Puis, chaque pression courte sur  accède à la fonction souhaitée :

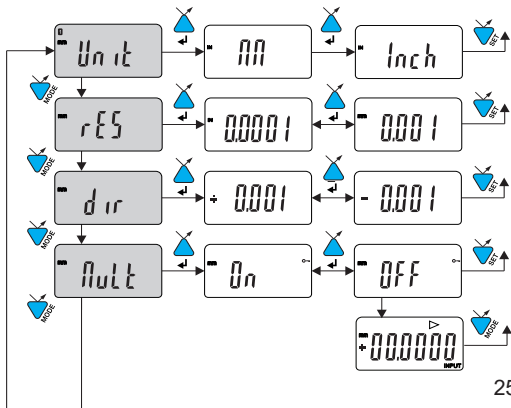



- Sélection de l'unité (mm or inch)
- Choix de la résolution 0.01 / 0.001 or 0.001 / 0.0001 (dependant de la version)
- Choix de la direction de mesure (sens positif ou négatif)
- Facteur de multiplication, active ou désactive le facteur de multiplication. (la valeur peut être modifiée si 0_n est confirmé avec le bouton ).
- Introduction d'un facteur de multiplication

 prochain digit  0...9  sauver MULT

..... suite

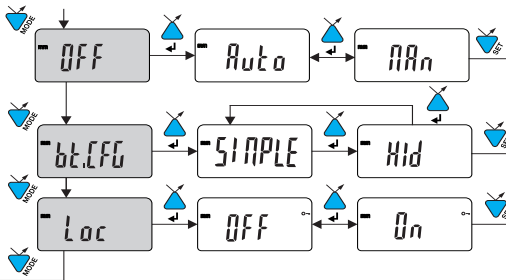
F



- Mode d'extinction automatique
AA n = désactivé, *Auto* = actif (après 10 min. par défaut).
- Sélection du profil *Bluetooth*[®] (dépendant de la version).
(Voir chap. 6 pour plus de détails).
Le symbole + indique le profil actif.
- Blocage du clavier
Seule la touche favori  reste active
(pour désactiver le blocage du clavier, presser  pendant 5 sec).

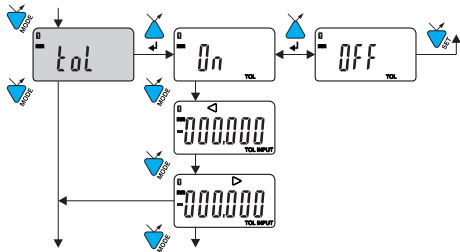

5. Introduction des limites de tolérances

Pour introduire ou modifier les limites de tolérances, il faut sélectionner le mode $tol \rightarrow 0n$, suivi d'une pression courte sur 



.....Introduire la limite de tolérance inférieure ◀

.....Introduire la limite de tolérance supérieure ▶

 prochain digit  0...9  sauve le PRESET

Remarque :

- Dans le cas de mesure de cotes d'intérieur, on peut croiser les indicateurs (rouge et jaune) en inversant l'ordre d'introduction des limites de tolérances (limite inférieure > limite supérieure).
- Il est possible d'introduire des limites de tolérances différentes sur les REF1 et REF2.

- Il est également possible d'afficher les limites de tolérance lorsque l'instrument travaille en mode MIN, MAX ou DELTA (TIR).
- Si aucune limites de tolérance n'ont été définies par l'utilisateur, l'instrument affichera les indicateurs de limites de tolérances ◀ [OK] ▶ , mais sans activer les indicateurs lumineux (rouge - vert - jaune).

F

6. Configuration *Bluetooth*[®] (selon modèle)

La procédure de connexion a été pensée au plus simple et se distingue par les 3 états ci-dessous:

- Symbole ✖ éteint mode déconnecté.
- Symbole ✖ clignote mode découverte.
- Symbole ✖ allumé mode connecté.

Les options suivantes peuvent être sélectionnées pour contrôler le module *Bluetooth*[®].

- On Activer le module *Bluetooth*[®] (démarrer le mode découverte).
- OFF Désactiver le module *Bluetooth*[®] (terminer la connexion active).
- rESEt Effacer les informations d'appairage.
- MAC Afficher l'adresse MAC (Media Access Control).

Deux profils *Bluetooth*[®] sont disponibles.

SIMPLE Profil non appairé (par défaut).

Hid Mode clavier virtuel (compatible avec un équipement récent sans installation d'un pilote).

- Remarque:

Les informations d'appairage *Bluetooth*[®] sont effacées lorsque le profil est modifié.

Connexion :

- 1° S'assurer que l'application et le matériel *Bluetooth*[®] compatibles sont actifs (PC, unité de mesure).
- 2° Démarrer l'instrument. Par défaut le module *Bluetooth*[®] est actif et l'instrument est connectable (mode découverte).
- 3° Dès que l'instrument est détecté la connexion est automatique. Si la connexion n'a pas été établie pendant que l'instrument se trouvait en mode découverte, réactiver le module *Bluetooth*[®] via le menu *bt / On*.
- 4° L'instrument est prêt à transmettre (mode connecté).

Seulement avec le profil d'appairage :

L'appairage de l'instrument avec le maître se fait automatiquement à la première connexion.

Pour connecter un instrument à un nouveau maître (nouvel appairage), les informations d'appairage doivent être effacées via le menu *bt / rESEt*.

6.1 Spécification *Bluetooth*[®]

Bande de fréquence	2.4GHz (2.402 - 2.480GHz)
Modulation	GFSK (Gaussian Frequency Shift Keying)
Puissance de sortie max.	Classe 3: 1mW (0dBm)
Portée	Espace ouvert : jusqu'à 15m Environnement industriel : 1-5m
Autonomie	Continuous : Jusqu'à 2 mois - Toujours connecté avec 4 valeurs /sec. Saver : jusqu'à 5 mois - L'instrument envoie la valeur quand la position change. Blind/Push : jusqu'à 7 mois - La valeur est envoyée de l'instrument (bouton) ou demandée par ordinateur.



F

7. Touche favori

La touche «favori» permet l'accès direct à une fonction prédéfinie et peut être configurée selon les besoins de l'utilisateur.

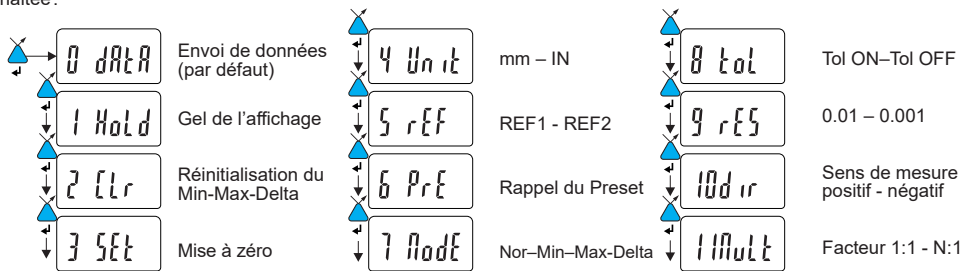
Pour attribuer une fonction à la touche «favori», effectuer une pression longue (>2s) sur , puis sélectionner la fonction souhaitée :





Validation de la sélection : Par une pression longue sur  ou une pression courte sur  ou .

Remarque : l'attribution de la fonction peut également se faire par RS 232, avec la commande <FCT + N° de fonction> exemple : Changement d'unité = <FCT4>.

8. Extinction

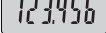
Le comparateur se met automatiquement en stand-by après 20 minutes de non utilisation, sauf si le mode Auto OFF est désactivé (voir chap.4 fonctions avancées).

Vous pouvez forcer le mode stand-by, par pression longue (>2s) sur  :   

En mode stand-by, la valeur d'origine est conservée par le capteur, et l'instrument redémarre automatiquement par un mouvement de la touche de mesure ainsi que par commande RS, ou par pression sur un bouton.

Il est possible d'éteindre complètement l'instrument pour une longue période de non utilisation, mais cela nécessitera une remise à zéro à l'enclenchement (perte de l'origine):

- Effectuer une pression longue (>4s) sur  :    → 

9. Réinitialisation de l'instrument

A tout moment, il est possible de restaurer les réglages initiaux de l'instrument, par une pression longue (>4s) simultanée

sur  et  jusqu'à l'affichage du message `rEEt`.

L'instrument conserve néanmoins les réglages de configuration (unité et résolution), ainsi que la dernière référence active.

10. Connexion de l'instrument

L'instrument peut être connecté à un périphérique, via un câble inductif, ou Power-RS (Power-USB). Voir en page 2 pour la connexion des câbles.

Possibilité de transmettre les valeurs mesurées, et piloter l'instrument à l'aide de rétro-commandes prédéfinies (liste des commandes principales, voir chap.11).

Remarque :

En mode Tolérance, les indicateurs lumineux des limites de tolérances ne restent allumés que quelques secondes lorsque la mesure est stabilisée. Par contre, ils resteront allumés en permanence si l'instrument est connecté et alimenté par le Power RS (USB).

11. Liste des commandes principales

Sélection et configuration

CHA+ / CHA-	Changement direction de mesure
FCT0 ...9...A...F	Attribution fonction «favori»
MM / IN	Changement unité de mesure
KEY0 / KEY1	Active / désactive le blocage clavier
MUL [+/-]xxx.xxxx	Modification facteur de multiplication
PRE [+/-]xxx.xxx	Modification valeur de preset
REF1 / REF2	Changement de la référence active
STO1 / STO0	Active / désactive le HOLD
TOL1 / TOL0	Active / désactive les tolérances
ECO1 / ECO0	Active / désactive le mode économique
LCAL dd.mm.yy	Modifie date dernière calibration
NCAL dd.mm.yy	Modifie date prochaine calibration
NUM x...x (jusqu'à 20 car.)	Modifie le numéro de l'instrument
TOL +/-xxx.xxx +/-yyy.yyy	Introduction limites de tolérances
MIN / MAX / DEL / NOR	Sélection mode MIN, MAX, Delta, Normal
CLE	Réinitialisation du MIN, MAX ou Delta
UNI1 / UNIO	Active / désactive le changement d'unité
OUT1 / OUT0	Active / désact. transmission données en continu
PRE ON / PRE OFF	Active / désact. la fonction Preset
PRE	Rappel du Preset
SET	Mise à zéro
RES1 / RES2 / RES3	Changement résolution
SBY xx	xx nombre de minutes avant stand-by
BT0/BT1	Active / désactive le mode <i>Bluetooth</i> [®]
BTRST	Réinitialisation de l'appairage

Interrogation

CHA?	Direction de mesure?
FCT?	Fonction «favori» active?
UNI?	Unité de mesure active?
KEY?	Blocage clavier?
MUL?	Facteur de multiplication?
PRE?	Valeur de preset?
REF?	Référence active?
STO?	Etat fonction HOLD?
TOL?	Valeur des limites de tol actuelles?
ECO?	Mode économique courant
LCAL?	Date dernière calibration?
NCAL?	Date prochaine calibration?
NUM?	Numéro de l'instrument?
?	Valeur actuelle? (mode Tol, valeur suivie de <=>)
MOD?	Mode actif (MIN, MAX, Delta ou Normal)?
SET?	Paramètres principaux de l'instrument?
ID?	Code d'identification de l'instrument?OUT1 /
Fonctions de maintenance	
BAT?	Etat pile (BAT1=Ok, BAT0=pile faible)
OFF	Extinct. complète (réveil par bouton ou RS)
RST	Réinitialisation de l'instrument
SBY	Mise en Stand by de l'instrument
VER?	Version et date du firmware
MAC?	Adresse MAC du module <i>Bluetooth</i> [®]

12. Spécifications

Echelon 0,001 mm (spécification IP)	01930315 (IP54)	01930317 (IP54)
Etendue de mesure:	12,5 mm	25 mm
Erreur max (résolution 0,01 mm):	10 μ m	10 μ m
Erreur max (résolution 0,001 mm):	3 μ m	4 μ m
Répétabilité:	2 μ m	
Poids:	119 g	123 g
Force de mesure (standard):	0,65-0,90 N	0,65- 1,15 N
Vitesse max. de déplacement:	1,7 m/s	
Nbre de mesure par seconde:	mesure: 10 mes/s mode MIN/MAX: 20 mes/s	
Unité de mesure:	métrique/anglaise (Inch)	
Preset maximum (résolution 0,01 mm):	\pm 9999,99 mm / \pm 399.9995 in	
Preset maximum (résolution 0,001 mm):	\pm 999,999 mm / \pm 39.99995 in	
Système de mesure:	Inductive system	
Alimentation:	1 batterie lithium 3 V, type CR2032, capacité 220mAh	
Consommation moyenne:	75 μ A	
Autonomie moyenne:	8'000 heures	
Sortie de données:	<i>compatible RS232 / Bluetooth® 5 (voir chapitre 6)</i>	
Température de travail (stockage):	+5 à +40°C (-10 à +60°C)	
Compatibilité électromagnétique:	selon EN 61326-1	
Spécification IP (selon IEC60529):	IP 54	
Fixation et encombrement:	fixation \varnothing 8h6 (3/8"), touche de mesure interchangeable M2,5 (4-48-UNF) (selon DIN 878)	

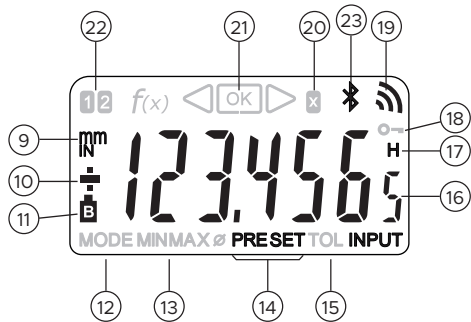
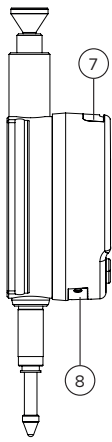
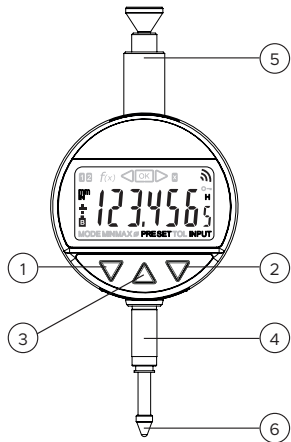

F

D

Beschreibung

1. MODE-Taste
2. SET-Taste
3. Favoriten-Taste
4. Einspannschaft \varnothing 8 oder 3/8"
5. Abhebe-Bolzen
6. Kugeltaster \varnothing 3/M2.5 oder 4-48-UNF
7. Buchse für Induktive Kabel
8. Batterieeinschub oder Netzkabelbuchse
9. Masseinheit (mm/INCH)
10. +/- Anzeige
11. Batterie schwach
12. Anzeige des Menüs Mode
13. MIN/MAX/DELTA-Modus
14. Preset-Modus
15. Toleranz-Modus
16. Anzeige von 6 Ziffern
17. Festhalten des Messwerts
18. Tastatursperre
19. Datenübertragung
20. Multiplikationsfaktor
21. Toleranzanzeiger
22. Aktive Referenz
23. *Bluetooth*[®]-Verbindung

1. Funktionalitäten des Instruments:

-  Das Instrument verfügt über zwei Betriebsarten: Basisfunktionen (mit direktem Zugang) und fortgeschrittene Funktionen. Neben den Konfigurationsfunktionen hat man Zugriff auf 2 Arbeitsreferenzen, den Modi MIN, MAX und DELTA (TIR), auf die Toleranzanzeige oder auf die Eingabe eines anderen Multiplikationsfaktors als 1:1. (siehe Kap. 3 und 4).
-  Mit der Taste „Favoriten“ kann man der hauptsächlich verwendeten Funktion einen direkten Zugriff zuzuweisen (siehe Kap. 6).
-  Ermöglicht die Zuweisung eines Presetwertes, die Reinitialisierung der Modi MIN/MAX, die Quittierung einer Auswahl und die Steuerung des Ausschaltens des Instruments.

D

- Parameter für Datenübertragung

4800Bds, 7 Bits, gerade Parität, 2 Stoppbits.

2. Starten

Eine Taste drücken.

Zur *Bluetooth*[®]-Verbindung (siehe Kap. 6).

3. Grundfunktionen

Eine kurze Betätigung von  ermöglicht einen direkten Zugriff auf die Grundfunktionen:

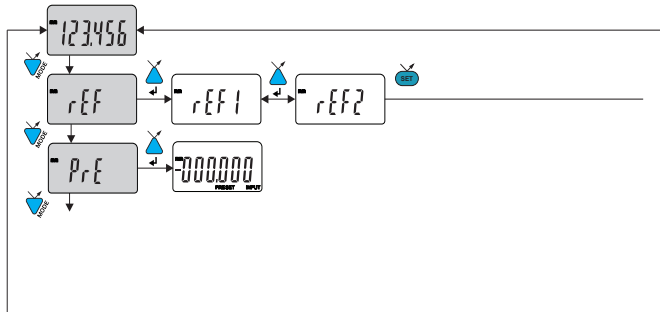

– Wahl der Referenz
(REF1 oder REF2)

– Eingabe des Presetwertes

 nächste Ziffer  0...9

 PRESET speichern

Anmerkung:

- Es ist möglich, jeder der beiden Referenzen einen unterschiedlichen Presetwert zuzuordnen. Ebenso kann man den Referenzen 1 und 2 unterschiedliche Toleranzgrenzen zuordnen.

..... Fortsetzung

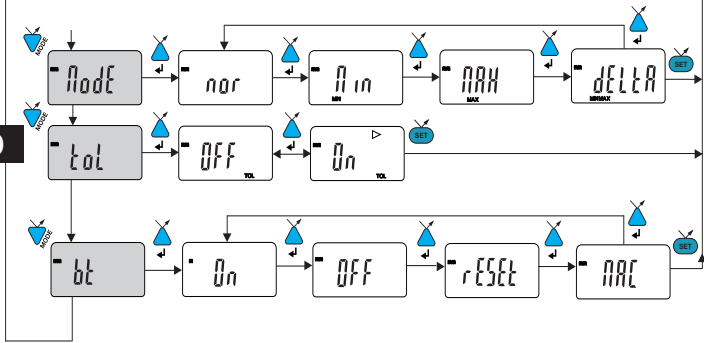



– Messen von MINIMUM, MAXIMUM, DELTA (TIR)

– Anzeige der Toleranzen (Eingabe der Toleranzgrenzen, siehe Kap. 5)

– Bluetooth® (version-sabhängig) Bluetooth® Modul ein-, ausschalten, zurücksetzen oder seine MAC-Adresse anzeigen.

4. Fortgeschrittene Funktionen

Eine lange Betätigung (>2s) von  ermöglicht es, auf die fortgeschrittenen Funktionen zuzugreifen. Anschließend führt jede kurze Betätigung von  zur gewünschten Funktion:

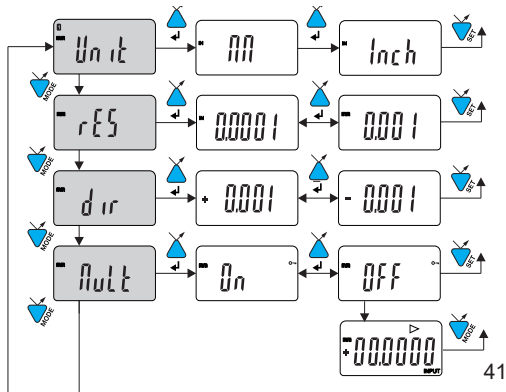



- Wahl der Einheit (mm oder Inch)
- Wahl des Ziffernschrittwerts
0.01 / 0.001 oder 0.001 / 0.0001 (versionsabhängig)

- Wahl der Messrichtung
(positive oder negative Richtung)

- Multiplikationsfaktor

Aktiviert oder deaktiviert den Multiplikationsfaktor (Wert kann geändert werden indem « **On** » mittels Taste bestätigt wird ).

- Eingabe eines Multiplikationsfaktors

 nächste Ziffer  0...9  speichern MULT

D

..... Fortsetzung

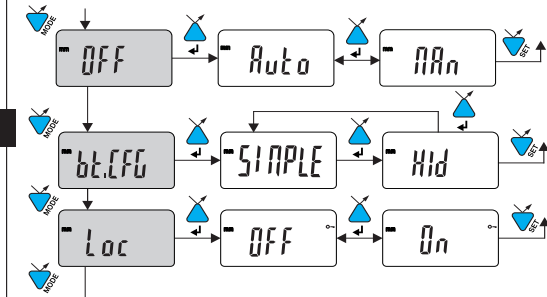

— Stand-by-Modus



PAN = deaktiviert, $Auto$ = aktiv
(standardmässig nach 10 Min.)

Auswahl des Bluetooth-Profiles

— (versionsabhängig).

(Siehe Kap. 6 für weitere Informationen).
Das + Symbol markiert die aktuelle Auswahl.

— Tastatursperre

Nur die Favoriten-Taste  bleibt aktiv
(um die Tastatursperre aufzuheben,  SET
5 s lang drücken).

5. Eingabe der Toleranzgrenzen

Um die Toleranzgrenzen einzugeben oder zu ändern, zu ändern Betriebsart $tol \rightarrow On$ wählen und dann kurz auf drücken  :

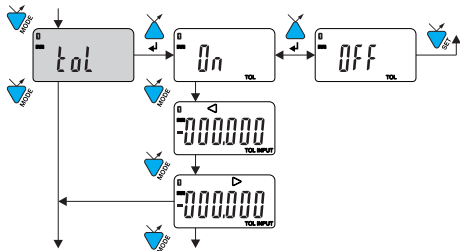



Anmerkung:

- Im Fall einer Messung der inneren Abmaße kann man die Anzeiger (rot und gelb) kreuzen, indem man die Eingabereihenfolge der Toleranzgrenzen umkehrt (untere Grenze > obere Grenze).
- Es ist möglich, verschiedene Toleranzwerte bei REF1 und REF2 einzugeben.

.....Die untere Toleranzgrenze eingeben ◀

.....Die obere Toleranzgrenze eingeben ▶

 nächste Ziffer  0...9  PRESET speichern

D

- Es ist auch möglich, die Toleranzwerte anzuzeigen, wenn das Instrument in der Betriebsart MIN, MAX oder DELTA (TIR) arbeitet.
- Falls keine Toleranzgrenzen festgelegt wurden, stellt das Instrument die Toleranzgrenzanzeige  dar, aber ohne die Leuchtmelder (rot – grün – gelb) zu aktivieren.“

6. *Bluetooth*[®]-Konfiguration (je nach Modell)

Der Verbindungsaufbau ist ganz einfach und wird in 3 Zuständen angezeigt:

D

- | | | |
|------------|----------------|------------------------|
| Kein | ✖ Symbol | keine Verbindung |
| Blinkendes | ✖ Symbol | bereit zur Verbindung |
| Stehendes | ✖ Symbol | Verbindung hergestellt |

Zur Konfiguration des *Bluetooth*[®]-Moduls stehen die folgenden Optionen zur Verfügung:

- | | |
|--------------|---|
| <i>On</i> | Aktiviert das <i>Bluetooth</i> [®] -Modul (Instrument kann gefunden werden). |
| <i>Off</i> | Deaktiviert das <i>Bluetooth</i> [®] -Modul (aktive Verbindung wird getrennt). |
| <i>Reset</i> | Hebt die <i>Bluetooth</i> [®] -Kopplung auf. |
| <i>MAC</i> | Zeigt die MAC (Media Access Control) -Adresse an. |

Zwei *Bluetooth*[®]-Profile stehen zur Auswahl:

SIMPLE Profil ohne Kopplung.

Hid Virtuelle Tastatur (Kompatibel mit aktuellen Geräten ohne Installation eines Treibers).

Anmerkung:

- Beim Wechsel des Profils wird die Bluetooth-Kopplung aufgehoben.

Verbindungsaufbau :

- 1° Stellen Sie sicher, dass die *Bluetooth*[®] Anwendung und das Gerät kompatibel und aktiv sind (PC, Messeinheit).
- 2° Schalten Sie das Instrument ein. Die *Bluetooth*[®]-Funktion ist standardmässig aktiviert und das Instrument kann verbunden werden (Verbindung wird gesucht).
- 3° Wurde keine Verbindung hergestellt während das Instrument sichtbar war, aktivieren Sie *Bluetooth*[®] erneut über das Menü *bt* / *On*.
- 4° Das Gerät ist bereit zum Senden (Verbindung hergestellt).

Kopplung :

Die Kopplung des Instruments mit dem Master erfolgt automatisch bei der ersten Verbindung. Um das Instrument mit einem neuen Master zu verbinden (neue Kopplung), muss die Kopplung über das Menü *bt* / *reset* gelöscht werden.

6.1 Technische Daten der *Bluetooth*[®]-Funktion



Frequenzband	2.4GHz (2.402 - 2.480GHz)
Modulation	GFSK (Gaussian Frequency Shift Keying)
Max. Ausgangsleistung	Klasse 3: 1mW (0dBm)
Reichweite	Im Freien: bis 15 m Industrienumgebung: 1-5 m
Autonomie	Continuous : bis zu 2 Monaten (Immer verbunden mit 4 Werten /sek). Saver : bis zu 5 Monaten (Das Gerät sendet die Werte nur wenn die Position geändert hat). Blind/Push : bis zu 7 Monaten (Der Wert wird von dem Gerät gesendet (Taste) oder vom Computer angefordert).

D

7. Favoriten-Taste

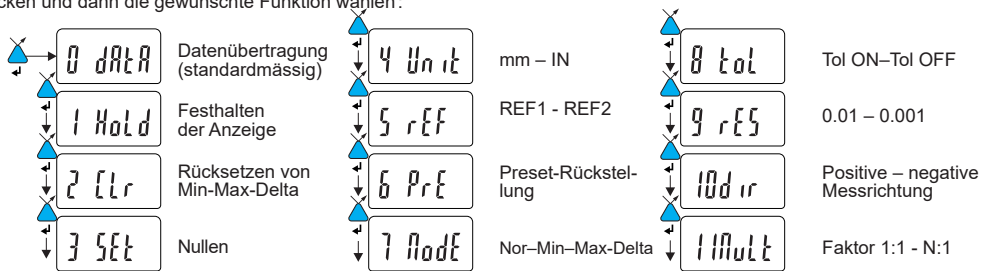
Die „Favoriten-Taste“ ermöglicht den direkten Zugriff auf eine zuvor bestimmte Funktion und kann entsprechend der Bedürfnisse des Nutzers konfiguriert werden. Um der „Favoriten-Taste“ eine Funktion zuzuordnen, muss man lange auf  drücken und dann die gewünschte Funktion wählen:



Bestätigung der Auswahl: Durch langes Drücken von  oder kurzes Drücken von  oder .

Anmerkung: Die Zuordnung der Funktion kann auch durch RS 232 erfolgen, mit der Steuerung <FCT + Funktions-Nr.>
Beispiel: Masseinheit = <FCT4>.



8. Ausschalten

Die Messuhr stellt sich nach 20 Minuten Nichtgebrauch automatisch auf Stand-By, außer wenn die Betriebsart Auto OFF deaktiviert ist (siehe Kap. 4, fortgeschrittene Funktionen).



Stand-By-Funktion durch langes Betätigen (>2s) von  erzwingen. 

Im Stand-By-Modus wird der Referenzwert vom Sensor beibehalten und das Instrument startet automatisch mit einer Bewegung des Messeinsatzes sowie über RS, oder eine Taste drücken.

Es ist möglich, das Instrument für eine lange Zeit des Nichtgebrauchs vollständig auszuschalten, aber das erfordert eine Rückstellung beim Einschalten (Verlust des Referenzwertes).

D - Lange (>4s) Drücken auf  : 

9. Rücksetzen des Instruments

Man kann die Werkseinstellungen des Instruments jederzeit mit einem langen (>4s), gleichzeitigen Drücken bis zur Anzeige der Meldung *rESEt* auf  und  wiederherstellen.

Das Instrument behält jedoch die Konfigurationseinstellungen (Einheit und Auflösung), sowie die letzte aktive Referenz.

10. Anschluss des Instruments

Das Instrument kann mit einem Induktive-Kabel oder Power-RS (Power-USB) an ein Peripheriegerät angeschlossen werden. Informationen zum Kabelanschluss finden Sie auf Seite 2.

Man kann die gemessenen Werte übertragen und das Instrument mit Hilfe von bestimmten Befehlen steuern. Liste der wesentlichen Steuerbefehle, siehe Kap. 11.

Anmerkung:

Im Toleranzmodus leuchten die Leuchtanzeigen der Toleranzgrenzen nur einige Sekunden, wenn die Messung stabilisiert ist. Sie bleiben jedoch ständig an, falls das Instrument durch das Power-RS- (USB-) Kabel angeschlossen ist und gespeist wird.

11. Liste der wesentlichen Steuerbefehle

Auswahl und Konfiguration

CHA+ / CHA-	Wechsel der Messrichtung
FCT0 ...9...A...F	Zuordnung der Funktion „Favorit“
MM / IN	Wechsel der Masseinheit
KEY0 / KEY1	Aktiviert / Deaktiviert die Tastatursperre
MUL [+/-]xxx.xxxx	Änderung des Multiplikationsfaktors
PRE [+/-]xxx.xxx	Änderung des Presetwertes
REF1 / REF2	Wechsel der aktiven Referenz
STO1 / STO0	Aktiviert / Deaktiviert den HOLD
TOL1 / TOL0	Aktiviert / Deaktiviert die Toleranzen
ECO1 / ECO0	Aktiviert / Deaktiviert ECO Modus
LCAL dd.mm.yy	Ändert das Datum der letzten Kalibrierung
NCAL dd.mm.yy	Ändert das Datum der nächsten Kalibrierung
NUM x...x (bis zu 20 Kar.)	Ändert der Instrumentnummer
TOL +/-xxx.xxx +/-yyy.yyy	Eingabe Toleranzgrenzen
MIN / MAX / DEL / NOR	Auswahl des Modus MIN, MAX, Delta, Normal
CLE	Rücksetzen von Min, Max oder Delta
UNI1 / UNIO	Aktiviert / Deaktiviert den Einheitswechsel
OUT1 / OUT0	Aktiviert / Deaktiviert die kontinuierliche Datenübertragung
PRE ON / PRE OFF	Aktiviert / Deaktiviert die Presetfunktion
PRE	Preset-Rückstellung
SET	Nullen
RES1 / RES2 / RES3	Ändern des Ziffernschrittwerts
SBY xx	Ändert die Dauer (xx Minuten) bis zum Stand-by
BT0/BT1	Aktiviert / deaktiviert die <i>Bluetooth</i> [®] -Funktion
BTRST	<i>Bluetooth</i> [®] - Kopplung aufheben

Abfragen

CHA?	Messrichtung?
FCT?	Funktion „Favorit“ aktiv?
UNI?	Masseinheit aktiv
KEY?	Tastatursperre?
MUL?	Multiplikationsfaktor?
PRE?	Presetwert?
REF?	Aktive Referenz?
STO?	HOLD Funktionsstatus?
TOL?	Wert der aktuellen Tol.-Grenzen?
ECO?	Actueller ECO Modus
LCAL?	Datum der letzten Kalibrierung?
NCAL?	Datum der nächsten Kalibrierung?
NUM?	Instrumentnummer?
?	Actueller Wert (Tol.-Modus, Wert gefolgt von <=>)
MOD?	Aktiver Modus (MIN, MAX, Delta oder Normal)?
SET?	Hauptparameter des Instruments?
ID?	Identifizierungscode des Instruments?

Wartungsfunktionen

BAT?	Batteriestatus (BAT1=Ok, BAT0=Batterie schwach)
OFF	Vollständ. Ausschalten (Einschalten mit Taste oder RS)
RST	Rücksetzen des Instruments
SBY	Versetzt das Instrument in den Stand-by-Modus
VER?	Revision und Datum der Firmware
MAC?	MAC-Adresse des <i>Bluetooth</i> [®] -Moduls

12. Spezifizierungen

0,001 mm Auflösung (IP Spezifikation)	01930315 (IP54)	01930317 (IP54)
Messbereich:	12,5 mm	25 mm
Fehlergrenze (Auflösung 0,01mm):	10 µm	10 µm
Fehlergrenze (Auflösung 0,001mm):	3 µm	4 µm
Wiederholbarkeit:	2 µm	
Gewicht:	119 g	123 g
Messkraft (Standard):	0,65-0,90 N	0,65- 1,15 N
Maximale Bewegungsgeschwindigkeit:	1.7m/s	
Anzahl der Messungen pro Sekunde:	Messung: 10 Mess/s	Betriebsart MIN/MAX: 20 Mess/s
Masseinheit:	mm / Inch	
Maximum Preset (Auflösung 0,01 mm):	±9999,99 mm / ±399.9995 in	
Maximum Preset (Auflösung 0,001 mm):	±999,999 mm / ±39.99995 in	
Messsystem:	Inductive system	
Versorgung:	1 x 3 V Lithiumbatterie, Typ CR2032, Kapazität 220 mAh	
Durchschnittlicher Verbrauch:	75 µA	
Durchschnittliche Autonomie:	8'000 Stunden	
Datenausgang:	RS232 Kompatibel / Bluetooth® 5 (siehe Kap.6)	
Arbeitstemperatur (Lagerung):	+5 bis +40°C (-10 bis +60°C)	
Elektromagnetische Verträglichkeit:	gemäß EN 61326-1	
IP Spezifikation (gemäß IEC60529):	IP 54	
Befestigung und Platzbedarf:	Ø 8h6 (3/8") Befestigung, austauschbarer M2.5 (4-48-UNF) Messeinsatz (gemäß DIN 878)	

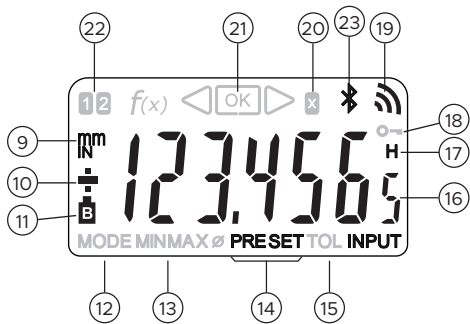
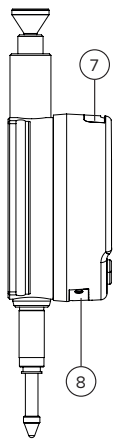
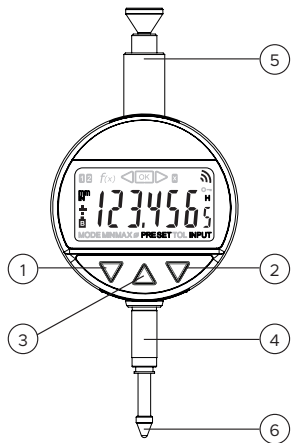

D



Descrizione

1. Tasto «MODE»
2. Tasto «SET»
3. Tasto «Preferito»
4. Gambo di fissaggio Ø 8 o 3/8"
5. Cappuccio di sollevamento
6. Contatto a sfera Ø 3/M2,5 o 4-48-UNF
7. Alloggiamento per cavo induttivo
8. Alloggiamento batteria o cavo Power
9. Unità di misura (mm/IN)
10. Indicatore +/-
11. Batteria scarica
12. Indicazione del menù Modalità
13. Modalità MIN/MAX/DELTA
14. Modalità Preset
15. Modalità Tolleranze
16. Visualizzazione a 6 cifre
17. Blocco del valore misurato
18. Blocco tastiera
19. Invio dati
20. Fattore di moltiplicazione
21. Indicatori di tolleranze
22. Riferimento attivo
23. Connessione *Bluetooth*[®]

1. Funzionalità dello strumento

-  Lo strumento dispone di 2 modalità operative: funzioni base (con accesso diretto) e funzioni avanzate. Oltre alle funzioni di configurazione, si ha accesso a 2 riferimenti operativi, alla modalità MIN, MAX e DELTA (TIR), alla visualizzazione delle tolleranze o all'inserimento di un fattore di moltiplicazione diverso da 1:1 (consultare i capitoli 3 e 4).
-  Il tasto «Preferito» permette di attribuire un accesso diretto alla funzione maggiormente utilizzata (consultare il capitolo 6).
-  Il tasto «SET» permette di impostare un valore di Preset, reinizializzare la modalità MIN/MAX, confermare una selezione e gestire lo spegnimento dello strumento.

- Parametri di trasmissione dati

4800 baud, bit di dati 7, parità pari, 2 bit di stop.

2. Avvio

Premere un tasto per accendere lo strumento.
Per una connessione *Bluetooth*[®] vedere il capitolo 6.

3. Funzioni di base

Ogni breve pressione su  permette l'accesso diretto alle funzioni base:

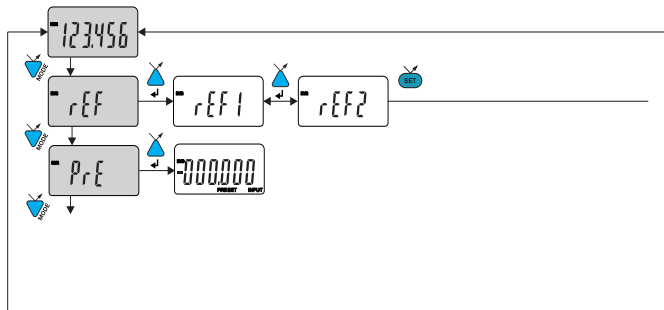

– Scelta del riferimento
(REF1 o REF2)

– Inserimento di un valore di Preset

 cifra successiva

 0...9  salva il PRESET

Nota:

- è possibile assegnare un valore di Preset differente ad ognuno dei 2 riferimenti. Analogamente è possibile impostare dei limiti di tolleranza diversi per i riferimenti 1 e 2.

..... segue

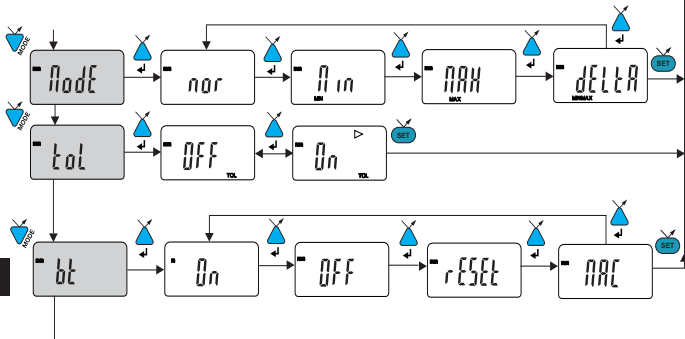

- Misura di MINIMO, MASSIMO, DELTA (TIR)
- Visualizzazione delle tolleranze (inserimento dei limiti di tolleranza, consultare il capitolo 5)
- *Bluetooth*[®] (a seconda della versione). Attivazione/ disattivazione, reimpostazione del modulo *Bluetooth*[®] o visualizzazione dell'indirizzo MAC.

4. Funzioni avanzate

Una pressione lunga (>2s) su  permette di accedere alle funzioni avanzate. Successivamente, ogni pressione corta su  dà accesso alla funzione desiderata:

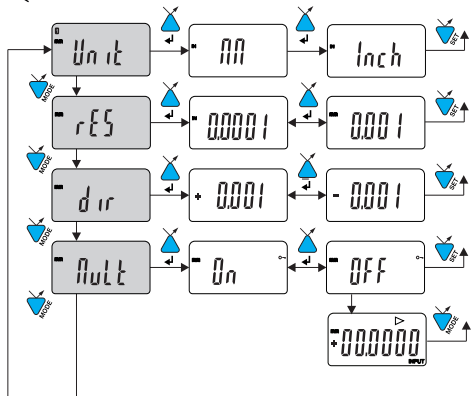

- Selezione dell'unità (mm o Inch)
- Scelta della risoluzione 0.01 / 0.001 o 0.001 / 0.0001 (a seconda della versione)
- Scelta della direzione di misura (senso positivo o negativo)
- Fattore di moltiplicazione
Attivazione o disattivazione (il valore può essere modificato se si conferma **On** con il tasto )
- Inserimento di un Fattore di moltiplicazione

 cifra successiva  0...9  salva MULT

..... segue

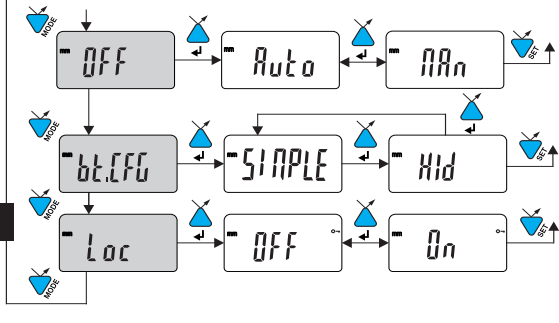

— Modalità di spegnimento automatico
PAN = disattiva, Auto = attiva (dopo
10 min. per default).

— Selezione del profilo *Bluetooth*[®]
(a seconda della versione).
(Vedere il capitolo 6 per altri dettagli).
Il simbolo + indica il profilo attivo.

— Blocco tastiera
Solo il tasto «Preferito» rimane
attivo (per disattivare il blocco tastiera,
premere SET per 5 s.).

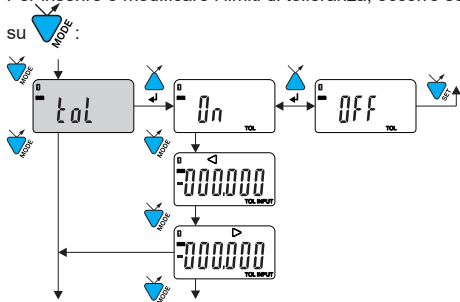

5. Inserimento dei limiti di tolleranza

Per inserire o modificare i limiti di tolleranza, occorre selezionare la modalità $tol \rightarrow 0n$, seguita da una breve pressione



.....Inserire il limite di tolleranza inferiore 

.....Inserire il limite di tolleranza superiore 

 cifra successiva  0...9  salva il PRESET

Nota:

- In caso di misura di dimensioni interne, è possibile incrociare i LED (rosso e giallo) invertendo l'ordine d'inserimento dei limiti di tolleranza (limite inferiore > limite superiore).
- È possibile inserire dei limiti di tolleranza diversi per REF1 e REF2.





- Quando lo strumento è in modalità MIN, MAX o DELTA (TIR), è possibile visualizzare anche i limiti di tolleranza.
- Se non è stato impostato nessun limite di tolleranza, lo strumento visualizza gli indicatori dei limiti di tolleranza  ma senza attivare i LED colorati (rosso – verde - giallo).

6. Configurazione *Bluetooth*[®] (in base al modello)

La procedura di connessione è stata pensata per essere semplice ed è indicata dai 3 seguenti stati:

- Simbolo  spentomodalità non connessa
- Simbolo  lampeggiantemodalità ricerca
- Simbolo  accesomodalità connessa

È possibile selezionare le seguenti opzioni per gestire il modulo *Bluetooth*[®].

-  Attiva il modulo *Bluetooth*[®] (avvia la modalità di ricerca).
-  Disattiva il modulo *Bluetooth*[®] (termina la connessione attiva).
-  Cancella le informazioni di associazione.
-  Visualizza l'indirizzo MAC (Media Access Control).

Sono disponibili due profili *Bluetooth*[®].

SIMPLE Profilo senza associazione (impostazione predefinita).

Hid Modalità tastiera virtuale (compatibile con dispositivi più recenti senza installazione di driver).

Nota:

- Le informazioni di associazione *Bluetooth*[®] vengono cancellate quando si modifica il profilo.

Connessione:

1° Attivare l'applicazione ed il dispositivo *Bluetooth*[®] compatibili (PC, visualizzatore).

2° Avviare lo strumento. Per impostazione predefinita il modulo *Bluetooth*[®] è attivo e lo strumento è collegabile (modalità ricerca).

3° Quando lo strumento viene rilevato, il collegamento è automatico. Se non è stata stabilita la connessione mentre lo strumento è in modalità di ricerca, riattivare il modulo *Bluetooth*[®] mediante il menù *bt* / *On*.

4° Lo strumento è pronto alla trasmissione (modalità connessa).

Associazione:

L'associazione dello strumento con la periferica avviene automaticamente alla prima connessione.

Per collegare lo strumento ad una nuova periferica (nuova associazione), è necessario cancellare le informazioni di associazione mediante il menù *bt* / *RESET*.



6.1 Specifiche *Bluetooth*[®]

Banda di frequenza	2.4GHz (2.402 - 2.480GHz)
Modulazione	GFSK (Gaussian Frequency Shift Keying)
Potenza massima in uscita	Classe 3: 1mW (0dBm)
Portata	Spazio aperto: fino a 15 m Ambiente industriale: 1-5 m
Autonomia	Continuous: fino a 2 mesi (Sempre connesso con 4 valori / sec). Saver: fino a 5 mesi (Lo strumento invia il valore quando cambia la posizione). Blind/Push: fino a 7 mesi (Il valore viene inviato dal tasto dello strumento o richiesto dal computer).

7. Tasto Preferito

Il tasto «Preferito» permette di accedere direttamente ad una funzione predefinita e può essere configurato secondo le esigenze dell'utente. Per assegnare una funzione al tasto «Preferito», premere a lungo (>2 s) il tasto , quindi selezionare la funzione desiderata.

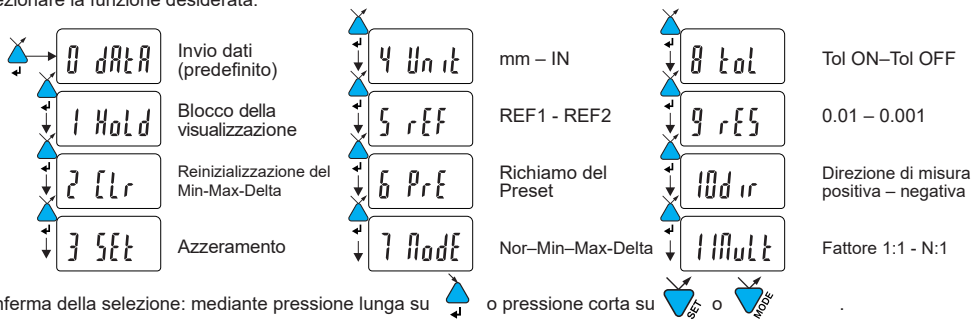

Nota: la funzione può essere assegnata anche mediante RS232, con il comando <FCT + N° di funzione>; esempio: Modifica unità di misura = <FCT4>.

8. Spegnimento

Il comparatore va automaticamente in stand-by dopo 20 minuti di inattività, tranne se la modalità Auto OFF è disattivata (consultare il capitolo 4 funzioni avanzate).

È possibile forzare la modalità stand-by con una pressione lunga (>2 s) su

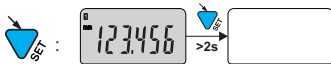

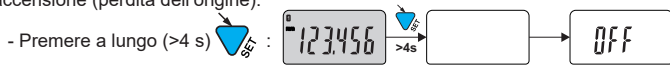

In modalità stand-by, il valore di origine è memorizzato dal sensore e lo strumento si riavvia automaticamente con un movimento del contatto di misura, un comando RS o una pressione di un tasto.

È possibile spegnere completamente lo strumento per un lungo periodo di non utilizzo, ma sarà necessario un azzeramento al momento della riaccensione (perdita dell'origine):



9. Reinizializzazione dello strumento

È possibile ripristinare le impostazioni originali dello strumento in qualsiasi momento con una pressione lunga (>4 s) contemporanea su  e  fino a visualizzare il messaggio `RESET`.

Lo strumento conserva tuttavia le impostazioni di configurazione (unità e risoluzione) e l'ultimo riferimento attivo.

10. Connessione dello strumento

Lo strumento può essere connesso ad una periferica mediante un cavo induttivo o Power-USB.

Vedere pagina 2 per il collegamento dei cavi.

È possibile trasmettere i valori misurati e pilotare lo strumento con dei comandi predefiniti (per l'elenco dei comandi principali consultare il capitolo 11).

Nota:

In modalità Tolleranze, i LED dei limiti di tolleranza rimangono accesi solo per pochi secondi mentre la misura si stabilizza. Resteranno accesi in modo fisso se lo strumento è collegato e alimentato con il cavo Power-USB.



11. Elenco dei comandi principali

Selezione e configurazione

CHA+ / CHA-	Modifica direzione di misura
FCT0 ...9...A...F	Assegnazione funzione «preferito»
MM / IN	Modifica unità di misura
KEY0 / KEY1	Attiva / disattiva il blocco tastiera
MUL [+/-]xxx.xxxx	Modifica fattore di moltiplicazione
PRE [+/-]xxx.xxx	Modifica valore di Preset
REF1 / REF2	Modifica del riferimento attivo
STO1 / STO0	Attiva / disattiva HOLD
TOL1 / TOL0	Attiva / disattiva le tolleranze
ECO1 / ECO0	Attiva / disattiva la modalità economica
LCAL dd.mm.yy	Modifica data ultima calibrazione
NCAL dd.mm.yy	Modifica data prossima calibrazione
NUM x...x (fino a 20 car.)	Modifica il numero dello strumento
TOL +/-xxx.xxx +/-yyy.yyy	Inserimento limiti di tol. attuali
MIN / MAX / DEL / NOR	Selezione modalità MIN, MAX, Delta, Normale
CLE	Reinizializzazione del MIN, MAX o Delta
UNI1 / UNIO	Attiva / disattiva il cambio di unità
OUT1 / OUT0	Attiva / disattiva trasmissione dati continua
PRE ON / PRE OFF	Attiva / disattiva la funzione Preset
PRE	Richiamo del Preset
SET	Azzeramento
RES1 / RES2 / RES3	Modifica risoluzione
SBY xx	xx numero di minuti prima dello stand-by
BT0/BT1	Attiva / disattiva la modalità <i>Bluetooth</i> [®]
BTRST	Reinizializzazione dell'associazione

Interrogazione

CHA?	Direzione di misura?
FCT?	Funzione «preferito» attiva?
UNI?	Unità di misura attiva?
KEY?	Blocco tastiera?
MUL?	Fattore di moltiplicazione?
PRE?	Valore di Preset?
REF?	Riferimento attivo?
STO?	Stato funzione HOLD?
TOL?	Valore dei limiti di tol. attuali?
ECO?	Attuale modalità economica?
LCAL?	Data ultima calibrazione?
NCAL?	Data prossima calibrazione?
NUM?	Numero dello strumento?
?	Valore attuale (modalità Tol, valore seguito da <=>)
MOD?	Modalità attiva (MIN, MAX, Delta o Normale)?
SET?	Parametri principali dello strumento?
ID?	Codice d'identificazione dello strumento?
Funzioni di manutenzione	
BAT?	Stato batteria (BAT1=Ok, BAT0=batteria scarica)
OFF	Spegnimento completo (riattivazione mediante tasto o RS)
RST	Reinizializzazione dello strumento
SBY	Messa in stand-by dello strumento
VER?	Versione Nr. e data del firmware
MAC?	Indirizzo MAC del modulo <i>Bluetooth</i> [®]

12. Specifiche

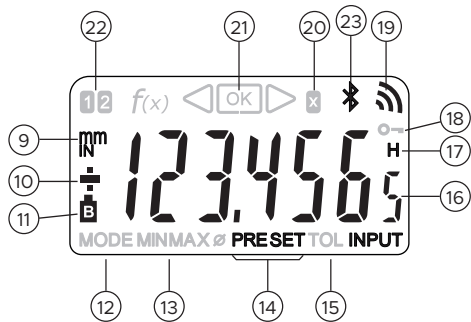
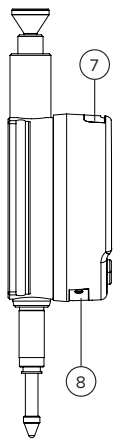
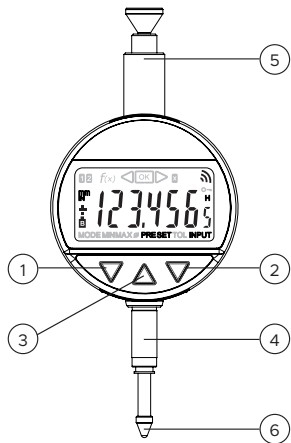

Risoluzione 0,001 mm (grado IP)	01930315 (IP54)	01930317 (IP54)
Corsa di misura:	12,5 mm	25 mm
Errore max. (risoluzione 0,01 mm):	10 μ m	10 μ m
Errore max. (risoluzione 0,001 mm):	3 μ m	4 μ m
Ripetibilità:	2 μ m	
Massa:	119 g	123 g
Forza di misura (standard):	0,65-0,90 N	0,65- 1,15 N
Velocità max. di spostamento:	1,7 m/s	
N. di misure al secondo:	misura: 10 mis/s modalità MIN/MAX: 20 mis/s	
Unità di misura:	metrica/imperiale	
Preset massimo (risoluzione 0,01 mm):	\pm 9999,99 mm / \pm 399.9995 in	
Preset massimo (risoluzione 0,001 mm):	\pm 999,999 mm / \pm 39.99995 in	
Sistema di misura:	sistema induttivo	
Alimentazione:	1 batteria al litio 3 V, tipo CR2032, capacità 220 mAh	
Consumo medio:	75 μ A	
Autonomia media:	8.000 ore	
Uscita dati:	<i>compatibile RS232 / Bluetooth® 5 (cap. 6)</i>	
Temperatura operativa (stoccaggio):	+5 ÷ +40 °C (-10 ÷ +60 °C)	
Compatibilità elettromagnetica:	secondo EN 61326-1	
Grado di protezione IP (secondo IEC60529):	IP 54	
Fissaggio e ingombro:	fissaggio \varnothing 8h6 (3/8"), contatto di misura intercambiabile M2,5 (4-48-UNF) (secondo DIN 878)	



Descripción

1. Botón Modo
2. Botón Configuración
3. Botón « Favoritos »
4. Eje de fijación \varnothing 8 o 3/8"
5. Corona de elevación
6. Palpador de bola \varnothing 3/M2.5 o 4-48-UNF
7. Alojamiento para cable inductivo
8. Alojamiento para batería o cable Power
9. Unidad de medida (mm/pulgadas)
10. Indicadores +/-
11. Batería baja
12. Indicación del menú Modo
13. Modo MIN/MAX/DELTA
14. Modo Preset
15. Modo Tolerancias
16. Visualización de 6 dígitos
17. Congelación del valor de medición
18. Bloqueo del botón
19. Envío de datos
20. Factor de multiplicación
21. Indicadores de tolerancia
22. Referencia activa
23. Conexión *Bluetooth*[®]

1. Funcionalidades del equipo

-  El equipo dispone de 2 modos de trabajo: funciones básicas (con acceso directo) y funciones avanzadas. Además de las funciones de configuración hay acceso a dos referencias de trabajo, en modo MIN, MAX y DELTA (TIR), en visualización de tolerancias o en la introducción de un factor de multiplicación distinto de 1:1. (ver cap. 3 y 4).
-  La tecla «favorito» atribuye un acceso directo a la función utilizada de manera principal (ver cap. 6).
-  Atribuye un valor predefinido, reinicializa el modo MIN/MAX, borra una selección y gestiona el apagado del equipo.

- Parámetros de transmisión de datos

4800Bds, 7 bits, paridad par, 2 bits de parada.

2. Inicio

Pulse un botón.

Para la conexión *Bluetooth*[®], (ver cap. 6)

3. Funciones básicas

Cada pulsación breve sobre  permite acceder directamente a las funciones básicas:

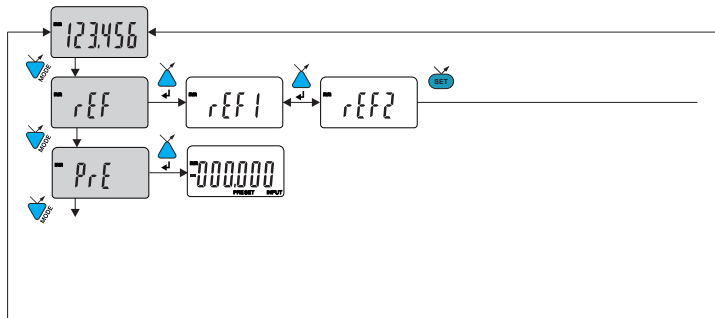

– Selección de la referencia (REF1 o REF2)

– Introducción de un valor predefinido

 dígito siguiente  0...9

 guarda el valor predefinido (PRESET)

Observaciones:

- Es posible atribuir un valor predefinido diferente a cada una de las 2 referencias. También pueden atribuirse límites de tolerancia diferentes a las referencias 1 y 2.

..... continuación

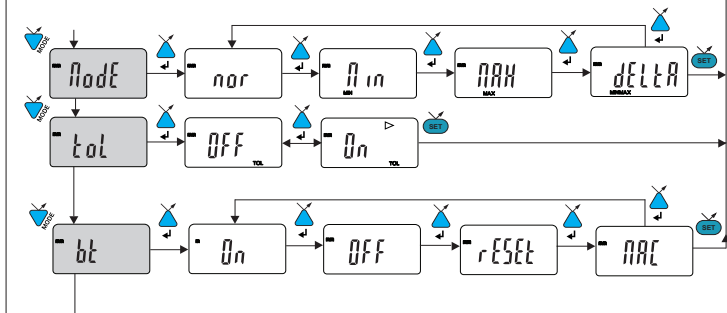

- Medición del MÍNIMO MÁXIMO, DELTA (TIR)
- Visualización de tolerancias (introducción de los límites de tolerancia, ver cap. 5)
- *Bluetooth*® (dependiendo de la versión). Activar / desactivar, reiniciar el versión *Bluetooth*® o mostrar la dirección MAC.

4. Funciones avanzadas

Al pulsar prolongadamente (>2 seg) sobre



accederá a las funciones avanzadas. Pulsando brevemente en

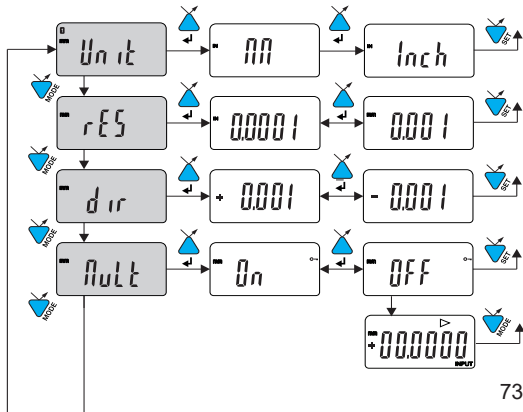

- Selección de la unidad (mm o In)
- Selección de resolución 0.01 / 0.001 o 0.001 / 0.0001 (depende de la versión)

- Selección de la dirección de medición (sentido positivo o negativo)

- Factor de multiplicación

Habilite o deshabilite el factor de multiplicación (el valor se puede cambiar si se confirma. $0n$ con el botón

- Introducción de un Factor de multiplicación



dígito siguiente



0....9



guarda MULT



..... continuación

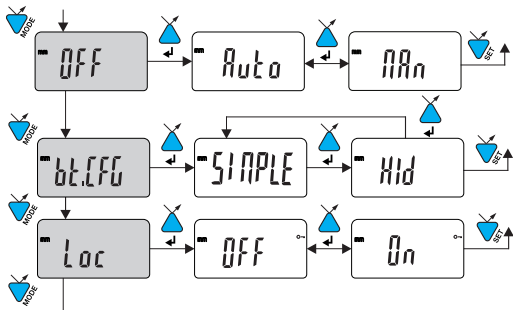

- Modo de apagado automático
RRn = desactivado, Auto = activo
(tras 10 min. por defecto).

- Selección del perfil Bluetooth® (según la versión).
(Ver cap. 6 para más detalles)
El símbolo + indica el perfil activo.

- Bloqueo del teclado
Solo la tecla favorito + queda activa
(para desactivar el bloqueo del teclado
pulse SET durante 5 segundos.).

5. Introducción de los límites de tolerancia

Para introducir o modificar los límites de tolerancia seleccione el modo $tol \rightarrow Un$ y a continuación presione brevemente

en  **MODE** :

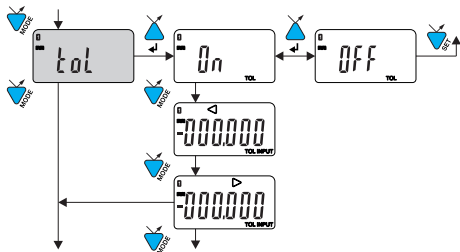

Observaciones :

- En el caso de medición de cotas de interior puede cruzar los indicadores (rojo y amarillo) invirtiendo el orden de introducción de los límites de tolerancia (límite inferior > límite superior).
- Es posible introducir límites de tolerancia diferentes en las REF1 y REF2.

.....Introduzca el límite de tolerancia inferior 



.....Introduzca el límite de tolerancia superior 

 dígito siguiente  0...9  guarda el valor predefinido (PRESET)

- También es posible mostrar los límites de tolerancia cuando el equipo trabaja en modo MIN, MAX o DELTA (TIR)
- Si el usuario no ha definido ningún límites de tolerancia, el instrumento mostrará los indicadores de límites de tolerancias  , pero sin activar los indicadores luminosos (rojo - verde - amarillo)

6. Configuración *Bluetooth*[®] (depediendo del modelo)

El procedimiento de conexión está pensado para que sea sencillo y se caracteriza por los 3 estados siguientes :

- Símbolo  apagadomodo desconectado
- Símbolo  parpadeantemodo detección
- Símbolo  encendidomodo conectado

Se pueden seleccionar las siguientes opciones para controlar el módulo *Bluetooth*[®].

-  Habilitar el módulo *Bluetooth*[®] (iniciar el modo de advertencia).
-  Desactiva módulo *Bluetooth*[®] (terminar la coexión activa).
-  Eliminar su información de emparejamiento.
-  Muestra la dirección MAC (Media Access Control).

Dos perfiles de *Bluetooth*[®] están disponibles.

SIMPLE Perfil no apareado (por defecto).

Hid Modo teclado virtual (compatible con equipos recientes sin instalación del controlador).

Observaciones :

- La información de *Bluetooth*[®] se borra cuando se cambia el perfil.

Conexión :

- 1° Compruebe que la aplicación y el *Bluetooth*[®] compatibles están activos (PC, unidad de medida).
- 2° Encienda el dispositivo. El módulo *Bluetooth*[®] está activo por defecto y el dispositivo es conectable (modo detección).
- 3° En cuanto se detecta el dispositivo, la conexión es automática. Si la conexión no se establece, durante que el instrumento se encuentre en modo búsqueda, reactivar el módulo Bluetooth vía el menú *bt / On*.
- 4° El dispositivo está listo para transmitir (modo conectado)

Solo con perfil emparejamiento :

El perfil del dispositivo con el maestro es automático en la primera conexión.

Para conectar un dispositivo a otro maestro (nuevo emparejamiento), hay que eliminar su información de emparejamiento desde el menú *bt / reset*.

6.1 Especificación *Bluetooth*[®]

Banda de frecuencia	2.4GHz (2.402 - 2.480GHz)
Modulación	GFSK (Gaussian Frequency Shift Keying)
Potencia máxima de salida	Clase 3: 1mW (0dBm)
Alcance	Espacio abierto: hasta 15m Entorno industrial: 1-5m
Autonomía	Continuous : hasta 2 meses (siempre conectados con 4 valores / seg). Saver : hasta 5 meses (El instrumento envía valor sólo cuando la posición ha cambiado). Blind/Push : hasta 7 meses (Valor se envía desde el (botón de instrumento) se puede solicitar a la computadora).

7. Tecla favorito

Con la tecla «favorito» se accede directamente a una función predefinida y puede configurarse según las necesidades del usuario. Para atribuir una función a la tecla «favorito» pulse prolongadamente sobre  y seleccione la función deseada:

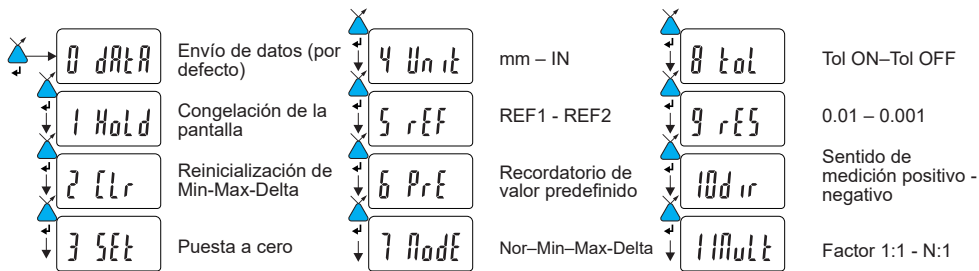

Validación de la selección: Pulsando prolongadamente en  o brevemente en  o en .

Observaciones: puede atribuirse también la función por RS232 con las teclas <FCT + N° de función> ejemplo: Cambio de unidad de medida= <FCT4>.

8. Apagado

El comparador hibernará automáticamente tras 20 minutos de inactividad salvo que el modo Auto OFF esté desactivado (ver Cap. 4, Funciones avanzadas).

Es posible forzar el modo de hibernación pulsando prolongadamente (> 2 seg)

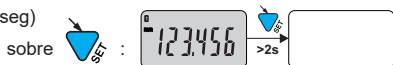



En modo hibernación el sensor conserva el valor del origen y el equipo se reanuda automáticamente por un movimiento del contacto de medición, por control RS, o pulsando un botón.

Es posible apagar el equipo en períodos largos en los que no se utilice pero esto implicará una puesta a cero al arranque de nuevo (pérdida del origen):



9. Reinicialización del equipo

Los ajustes iniciales del equipo pueden restaurarse en cualquier momento pulsando prolongadamente (> 4 seg) y al mismo tiempo  y  hasta que se muestre el mensaje *rESEt*.

El equipo conservará los ajustes de configuración (unidad y resolución) y la última referencia activa.

10. Conexión del equipo

El equipo puede conectarse a un periférico con un cable inductivo, o Power-RS (Power-USB). Consultar la página 2 para la conexión de los cables.

Los valores medidos pueden transmitirse y puede controlarse el instrumento con comandos predefinidos (lista de comandos principales en el cap. 11).

Observaciones :

En modo Tolerancia, los indicadores luminosos de los límites de tolerancia se iluminan sólo unos segundos cuando la medición se ha estabilizado. Sin embargo se mantendrán iluminados si el instrumento está conectado y recibe alimentación con el cable Power RS (USB).

11. Lista de comandos principales

Selección y configuración

CHA+ / CHA-	Cambio de dirección de medición
FCT0 ...9...A...F	Atribución de función «favorito»
MM / IN	Cambio de unidad de medida
KEY0 / KEY1	Activa / desactiva el bloqueo de teclado
MUL [+/-]xxx.xxxx	Modificación del factor de multiplicación
PRE [+/-]xxx.xxx	Modificación del valor predefinido
REF1 / REF2	Cambio de la referencia activa
STO1 / STO0	Activa / desactiva el HOLD
TOL1 / TOL0	Activa / desactiva las tolerancias
ECO1 / ECO0	Activa / desactiva el modo económico
LCAL dd.mm.yy	Modifica fecha de última calibración
NCAL dd.mm.yy	Modifica fecha de próxima calibración
NUM x...x (hasta 20 char)	Modifica el número del instrumento
TOL +/-xxx.xxx +/-yyy.yyy	Introducción de los límites de tol. actuales
MIN / MAX / DEL / NOR	Selección del modo MIN, MAX, Delta, Normal
CLE	Reinicio del MIN, MAX o Delta
UNI1 / UNI0	Activa / desactiva el cambio de unidad
OUT1 / OUT0	Activa / desact. transmisión continua de datos
PRE ON / PRE OFF	Activa / desactiva la función Preset
PRE	Recordatorio del Preset
SET	Puesta a cero
RES1 / RES2 / RES3	Cambio de resolución

SBY xx xx cantidad de minutos antes de la hibernación

BT0/BT1 Activa / desactiva el modo *Bluetooth*[®]
 BTRST Reinicialización del emparejamiento

Pregunta

CHÁ?	¿Sentido de medición?
FCT?	¿Función «favorito» activada?
UNI?	¿Unidad de medida activada?
KEY?	¿Bloqueo de teclado?
MUL?	¿Factor de multiplicación?
PRE?	¿Valor predefinido?
REF?	¿Referencia activa?
STO?	¿Estado de la función HOLD?
TOL?	¿Valor de límites de tol. actuales?
ECO?	¿Modo económico actual?
LCAL?	¿Fecha de última calibración?
NCAL?	¿Fecha de próxima calibración?
NUM?	¿Número del instrumento?
?	¿Valor actual (modo Tol, valor seguido de <=>)?
MOD?	¿Modo activo? (MIN, MAX, Delta o Normal)
SET?	¿Configuración principal del instrumento?
ID?	¿Código de identificación del instrumento?
Funciones de mantenimiento	
BAT?	Estado batería (BAT1=Ok, BAT0=batería baja)
OFF	Apagado completo (arranque con botón o RS)
RST	Reinicialización del equipo
SBY	Hibernación del equipo
VER?	Revisión y fecha del firmware.

MAC? Dirección MAC del módulo *Bluetooth*[®]

12. Especificaciones

Resolución 0,001 mm (especificación IP)	01930315 (IP54)	01930317 (IP54)
Alcance de la medición:	12,5 mm	25 mm
Error máx. (resolución 0,01 mm):	10 μ m	10 μ m
Error máx. (resolución 0,001 mm):	3 μ m	4 μ m
Repetibilidad:	2 μ m	
Peso:	119 g	123 g
Fuerza de medición (estándar):	0,65-0,90 N	0,65- 1,15 N
Velocidad máxima de desplazamiento:	1,7 m/seg.	
N° de mediciones por segundo:	medición: 10 med/s modo MIN/MAX: 20 med/seg.	
Unidad de medida:	métrico / imperial (pulgadas)	
Preset máximo (resolución 0,01 mm):	\pm 9999,99 mm / \pm 399.9995 in	
Preset máximo (resolución 0,001 mm):	\pm 999,999 mm / \pm 39.99995 in	
Sistema de medida:	Inductive system (patentado)	
Alimentación:	1 batería litio 3 V, tipo CR2032, capacidad 220mAh	
Consumo medio:	75 μ A	
Autonomía media:	8.000 horas	
Salida de datos:	<i>compatible RS232 / Bluetooth® 5 (cap. 6)</i>	
Temperatura de trabajo (almacenamiento):	+5 hasta +40°C (-10 hasta +60°C)	
Compatibilidad electromagnética:	según EN 61326-1	
Especificación IP (según IEC60529):	IP 54	
Fijación y volumen:	fijación \varnothing 8h6 (3/8"), contacto de medición intercambiable M2.5 (4-48-UNF) (según DIN 878)	

CERTIFICATE OF CONFORMITY

We certify that this instrument has been manufactured in accordance with our Quality Standard and tested with reference to masters of certified traceability by the National Office of Metrology.

CERTIFICAT DE CONFORMITE

Nous certifions que cet instrument a été fabriqué et contrôlé selon nos normes de qualité et en référence avec des étalons dont la traçabilité est reconnue par l'office national de métrologie.

QUALITÄTSZEUGNIS

Wir bestätigen, dass dieses Gerät gemäss unseren internen Qualitätsnormen hergestellt wurde und mittels Normalen mit anerkannter Rückverfolgbarkeit, kalibriert durch das Nationalamt für Metrologie, geprüft worden ist.

CERTIFICATO DI CONFORMITÀ

Certifichiamo che questo strumento è stato prodotto in conformità con i nostri standard di Qualità e testato con riferimento a campioni la cui tracciabilità è certificata dall'Istituto Nazionale di Metrologia.

CERTIFICADO DE CONFORMIDAD

Certificamos que este instrumento ha sido fabricado conforme a nuestras normas de calidad y ha sido controlado en relación con patrones de trazabilidad reconocida por la oficina nacional de metrología.

Calibration certificate

Because we make our instruments in batches, you may find that the date on your calibration certificate is not current. Please be assured that your instruments are certified at point of production and then held in stock in our warehouse in accordance with our Quality Management System ISO 9001. Re-calibration cycle should start from date of receipt.

Certificat d'étalonnage

En raison de la fabrication de nos instruments par lots de production, il est possible que la date de votre certificat d'étalonnage ne soit pas actuelle. Nous garantissons que nos instruments sont certifiés au moment de leur fabrication puis stockés conformément à notre système de gestion de la qualité ISO 9001. Le cycle de réétalonnage peut commencer à partir de la date de réception.

Zertifikat

Da wir unsere Instrumente in Serien herstellen, kann es sein, dass das Datum auf dem Zertifikat nicht aktuell ist. Die Instrumente sind jedoch ab der Herstellung zertifiziert und werden dann gemäß unserem Qualitätsmanagementsystem ISO 9001 in unserem Lager aufbewahrt. Der Nachkalibrierungszyklus kann ab dem Empfangsdatum beginnen.

Certificato di taratura

Poiché i nostri strumenti sono prodotti in lotti, la data del certificato di taratura potrebbe non essere attuale. Garantiamo che i nostri strumenti sono certificati al momento della produzione e poi tenuti a magazzino in conformità con il nostro Sistema di Gestione della Qualità ISO 9001. Il ciclo di ritaratura può iniziare dalla data di ricevimento.

Certificado de calibración

Puesto que fabricamos nuestros instrumentos por lotes, puede que la fecha de su informe de prueba / certificado de calibración no esté al día. Asegúrese de que los instrumentos estén certificados en nuestro lugar de producción y estén almacenados en nuestro almacén conforme a nuestro sistema de control de calidad ISO 9001. El ciclo de recalibración puede empezar a partir de la fecha de recepción.

U.S./Canada Certification



TESA

DIALTRONIC BT



This device contains
FCC ID: 2AAQS-ISP091201
IC: 11306A-ISP091201

NOTICE :

This device complies with Part 15 of the FCC Rules and with RSS-210 of Industry Canada. Operation is subject to the following two conditions.

(1) this device may not cause harmful interference, and

(2) this device must accept any interference received, including interference that may cause undesired operation.

NOTE :

This equipment has been tested and found to comply with the limits for a Class A digital device, pursuant to Part 15 of the FCC Rules. These limits are designed to provide reasonable protection against harmful interference when the equipment is operated in a commercial environment. This equipment generates, uses, and can radiate radio frequency energy and, if not installed and used in accordance with the instruction manual, may cause harmful interference to radio communications. Operation of this equipment in a residential area is likely to cause harmful interference in which case the user will be required to correct the interference at his own expense.

Radiofrequency radiation exposure Information :

This equipment complies with FCC radiation exposure limits set forth for an uncontrolled environment. This equipment should be installed and operated with minimum distance of 20 cm between the radiator and your body.

This transmitter must not be co-located or operating in conjunction with any other antenna or transmitter.

Brazil Certification

Description:

This module is based on Nordic Semiconductor nRF8001 μ Blue *Bluetooth*[®] Low Energy Platform. The nRF8001 is a single chip transceiver with an embedded baseband protocol engine, suitable for ultra-low power wireless applications conforming to the *Bluetooth*[®] Low Energy Specification contained within v4.0 of the overall *Bluetooth*[®] specification. The nRF8001, used in the current revision of ISP091201, is a production product using a RoM for the baseband protocol engine.

Este equipamento opera em caráter secundário, isto é, não tem direito à proteção contra interferência prejudicial, mesmo de estações do mesmo tipo e não pode causar interferência a sistemas operando em caráter primário.

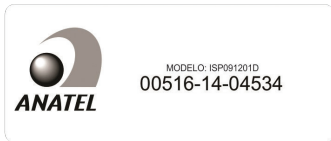

Mexico certification

Contiene modulo inalámbrico
Marca: TESA
Modelo: ISP091201D
IFT: RCPSYIS14-0655

La operación de este equipo está sujeta a las siguientes dos condiciones: (1) es posible que este equipo o dispositivo no cause interferencia perjudicial y (2) este equipo o dispositivo debe aceptar cualquier interferencia, incluyendo la que pueda causar su operación no deseada.

Korea South certification

MSIP-CRM-iNs-ISP091201

Class A Equipment (Industrial Use)

이 기기는 업무용(A급) 전자파적합기기로서 판매자 또는 사용자는 이 점을 주의하시기 바라며, 가정 외의 지역에서 사용하는 것을 목적으로 합니다.

Japan certification



R

001-A06167

Taiwan Certification

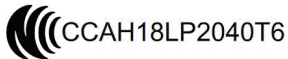

警語

經型式認證合格之低功率射頻電機,非經許可,公司、商號或使用者均不得擅自變更頻率、加大功率或變更原設計之特性及功能。

低功率射頻電機之使用不得影響飛航安全及干擾合法通信;經發現有干擾現象時,應立即停用,並改善至無干擾時方得繼續使用。

前項合法通信,指依電信法規定作業之無線電通信。低功率射頻電機須忍受合法通信或工業、科學及醫療用電波輻射性電機設備之干擾。

Note :



TESA
TECHNOLOGY

1977.0322311 – ME1977032

